

12-1-TW

water-cooled



Different modular switch

units available:

- single push-button
- double push-button
- up/down (4 push-buttons)
- single push-button with potentiometer

350 Amp./100% duty cycle (DC)
260 Amp./100% duty cycle (AC)

12-1-TW

water-cooled

- Equipment: **A** standard
B gas lens large
D gas lens jumbo
E gas lens mini



Back cap long
12391311



Back cap short
12391301



Insulator
12389001

Collet L64mm
12□□6401 for 1,0/1,6/2,4/3,2/4,0
□□ Please fill in size

Collet L66mm
12□□6601 for 1,0/1,6/2,4/3,2/4,0
□□ Please fill in size



A

B

D

E



Gas lens insulator
12389011



Gas lens insulator jumbo
20089021



Collet body
12396□□1 for 1,6/2,4/3,2/4,0
□□ Please fill in size



Gas lens large
12396□□2 for 1,6/2,4/3,2/4,0
□□ Please fill in size



Gas lens jumbo
12396□□4 for 1,6/2,4/3,2/4,0
□□ Please fill in size



Gas lens mini
12396□□3 for 1,6/2,4/3,2/4,0
□□ Please fill in size



Ceramic nozzle L44mm
for standard casing
and gas lens mini
Please state size



Ceramic nozzle L42mm
for gas lens large
Please state size
Also available in
special length L76mm



Ceramic nozzle L48mm
for gas lens jumbo
Please state size



Ceramic nozzle L44mm
for gas lens mini
and standard casing
Please state size

HSN 740



12-1-TW water-cooled

350 Ampere at 100% duty cycle (DC) - 260 Ampere at 100% duty cycle (AC)

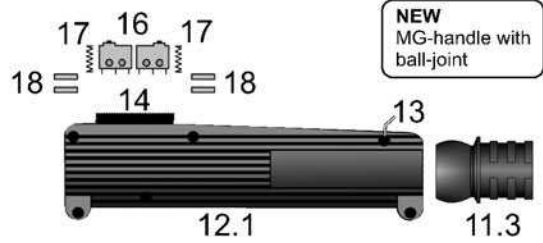
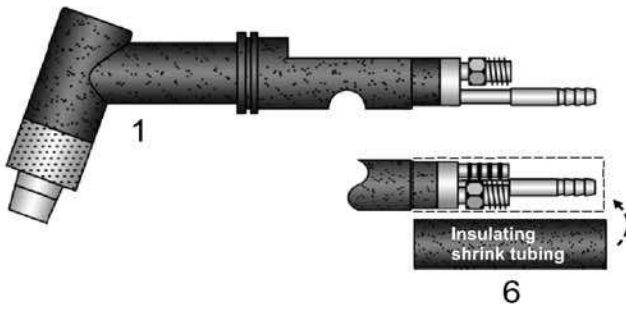

Forma WIG-handle with ball joint and different modular switch units

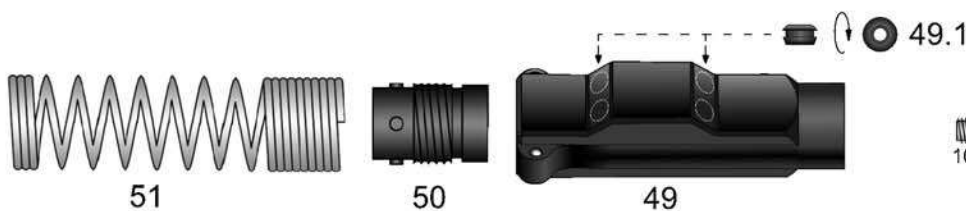
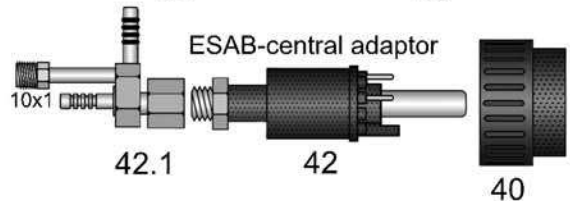
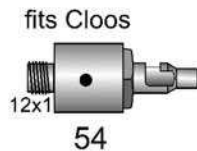
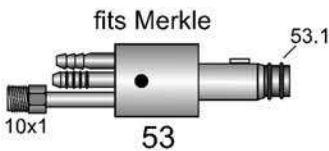
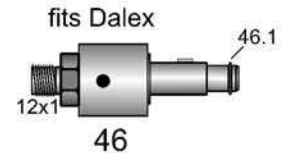
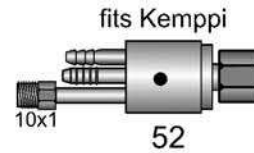
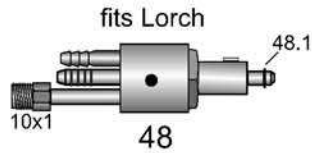
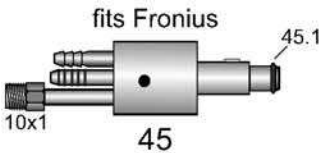
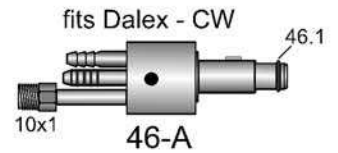
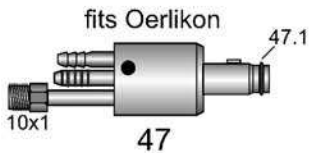
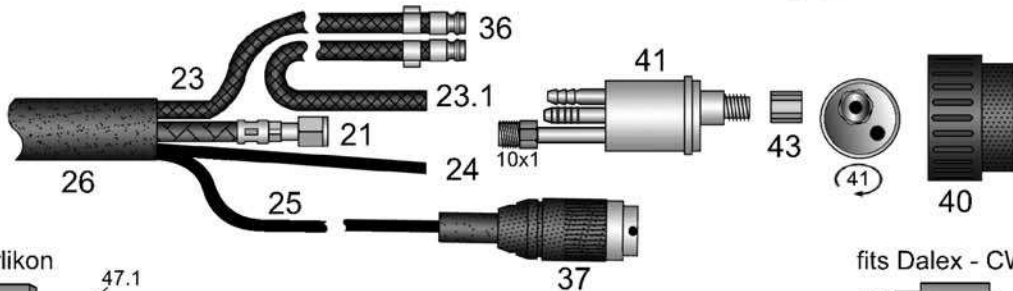

HSN 520



Equipment: **A** standard
B gas lens Holch
D gas lens jumbo
E gas lens mini

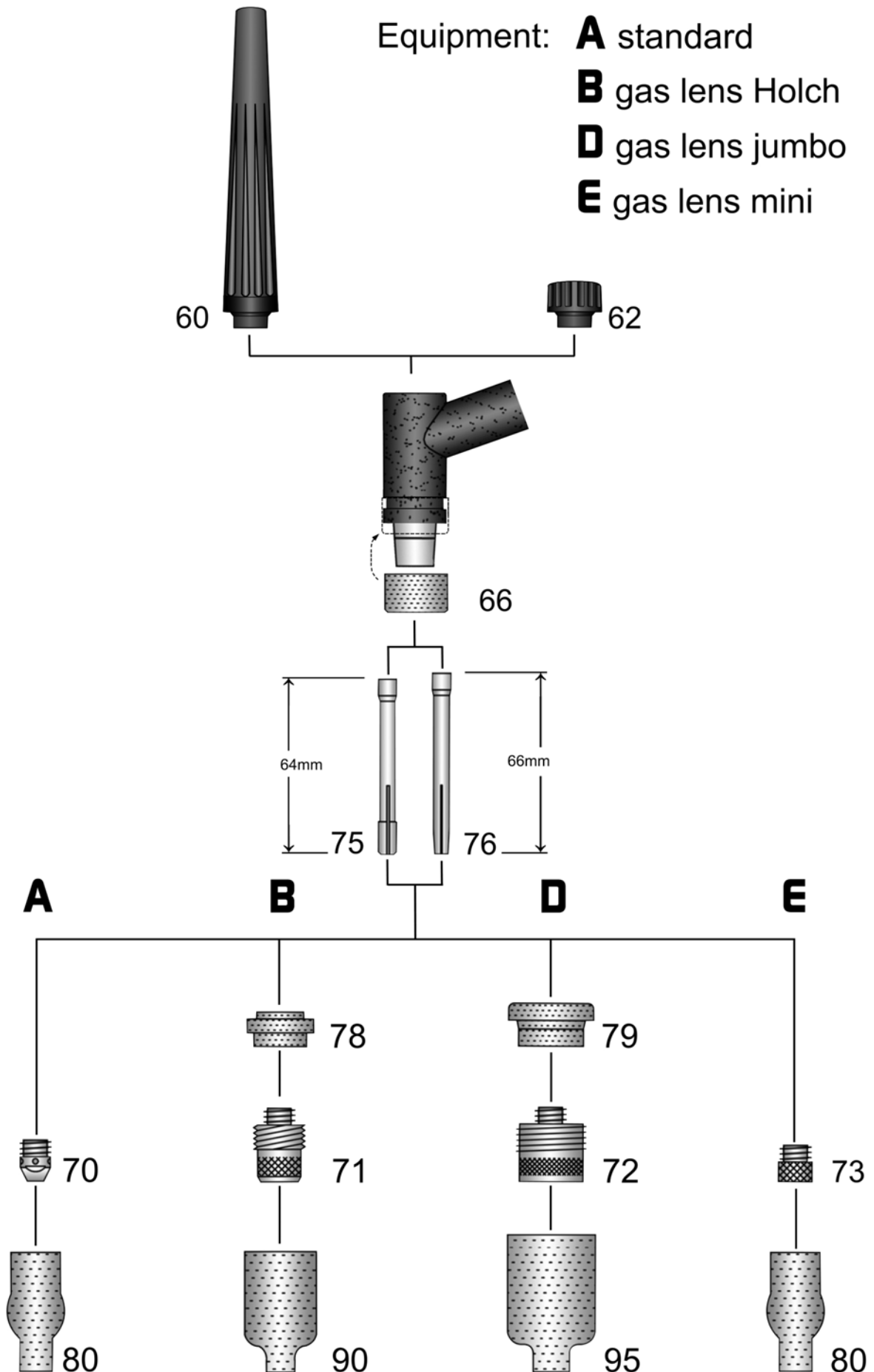

HSN 103

12-1-TW

Welding-torch TIG water-cooled

350A at 100% duty cycle (DC) - 260A at 100% duty cycle (AC)

Art.-No.

Torches with first meter leather hose. Prices without leather on request. Machine side separate connections with Tichel plug.

In variation to the torches listed below, the torches can also be produced with other power/ water cables (e.g. HT 180 silicone superflexible). This can also be combined with hoses in a lot of different qualities. Torches and cable assemblies can be produced in excess lengths. Please find the different options and surcharges in the attachment "Custom made products" appendix C. We produce torches for more than 40 different brands of machines with different connection systems.

12300401 Torch 12-1-TW / 4m spare cable assembly ST 80 PVC-NIT

12300801 Torch 12-1-TW / 8m spare cable assembly ST 80 PVC-NIT

The following torches are equipped with very flexible and heat resistant HT110 rubber fabric hoses.

1230040P Torch 12-1-TW-PLUS / 4m spare cable assembly HT 110

1230080P Torch 12-1-TW-PLUS / 8m spare cable assembly HT 110

TIG-spare cable assemblies in different qualities, machine side with separate connections and Tichel plug, or, if ordered so, with the following connection systems:

wig92402 TIG-spare cable assembly water-cooled 4m - please state desired design!

wig92802 TIG-spare cable assembly water-cooled 8m - please state desired design!

The following surcharges for machine side connections are only to find prices quickly. Please use our catalogue "TIG machine side connections" to find a "T" number which identifies a machine side connection system completely.

29002102 Surcharge: machine side power/water plug SK35 bayonet connection AD13mm

29000201 Surcharge: machine side with EURO central adapter

29002109 Surcharge: machine side power/water plug fits Merkle with 2 O-rings

29002106 Surcharge: machine side power/water plug fits Fronius with 1 O-ring

29002101 Surcharge: machine side power/water plug fits Dalex with 1 O-ring

29002108 Surcharge: machine side power/water plug fits Oerlikon with 1 O-ring

29002104 Surcharge: machine side power/water plug fits Lorch SK35 + gas-nipple

29002105 Surcharge: machine side power/water plug fits Kemppi IT-G1/4"

29002110 Surcharge: machine side power/water plug fits Cloos

29000212 Surcharge: machine side fits ESAB central adapter, 4 pins installed at position 3,4,5,6

poti2901 Surcharge: 1 button with additional potentiometer

ud290001 Surcharge: 4 switches > up / down

Please note that there might be additional charges for special control line plugs. See appendix D.

1 12391001 Torch body 12-1-TW

6 18050002 Ignition insulating hose L75mm / ID39mm down to ID13mm

11.1 91914601 Forma TIG handle with screws, ball joint, without modular switch unit

11.2 91914602 Forma screw for handle

11.3 91914603 Forma hose bracket with ball joint ID21,5mm (also fits MG-handle)

11.4 91914611 Forma modular switch unit: 1 button with connecting adapter

11.5 91914621 Forma modular switch unit: 2 buttons with connecting adapter

11.6 91914631 Forma modular switch unit: 1 button + potentiometer (10k) with connecting adapter

11.7 91914641 Forma modular switch unit: 2 buttons + up/down (4 switches) with connecting adapter

11.8 91914651 Forma connecting adapter fits control line to modular switch unit

12-1-TW

Welding-torch TIG water-cooled

350A at 100% duty cycle (DC) - 260A at 100% duty cycle (AC)

Art.-No.		
N.i.	91914661	Forma switch module safety nipple
12.1	91914061	MG-handle with ball joint, push-button, 2 return springs, 2 microswitches and 4 cylindrical pins
13	91914421	MG-tapping screw
14	91915002	MG-push button
16	91914121	MG-microswitch
17	91914221	MG-return spring
18	91914321	MG-cylindrical pin

Please state the machine side connection for the following power/ water cables.

For 4m long torches:

20	12942401	ST 80 PVC-NIT power/water cable 10mm ² 12/18/20-TW / 4m
20	12942404	HT 105 PVC-NIT power/water cable 10mm ² 12/18/20-TW / 4m
20	12942403	HT 110 rubber fabric hose power/water cable 10mm ² 12/18/20-TW / 4m
20	12942405	HT 130 TPE power/water cable 10mm ² 12/18/20-TW / 4m
20	12942408	HT 180 silicone super flexible power/water cable 10mm ² 12/18/20-TW / 4m

For 8m long torches:

20	12942801	ST 80 PVC-NIT power/water cable 10mm ² 12/18/20-TW / 8m
20	12942804	HT 105 PVC-NIT power/water cable 10mm ² 12/18/20-TW / 8m
20	12942803	HT 110 Rubber fabric hose power/water cable 10mm ² 12/18/20-TW / 8m
20	12942805	HT 130 TPE power/water cable 10mm ² 12/18/20-TW / 8m
20	12942808	HT 180 silicone super flexible power/water cable 10mm ² 12/18/20-TW / 8m

The following power/ water cables are produced with M10x1 inner thread at the machine side for EURO central adapters. (fits to all Holch connection systems with outer thread M10x1).

For 4m long torches:

21	12942411	ST 80 PVC-NIT power/water cable 10mm ² 12/18/20-TW / 4m
21	12942414	HT 105 PVC-NIT power/water cable 10mm ² 12/18/20-TW / 4m
21	12942413	HT 110 rubber fabric hose power/water cable 10mm ² 12/18/20-TW / 4m
21	12942415	HT 130 TPE power/water cable 10mm ² 12/18/20-TW / 4m
21	12942418	HT 180 silicone super flexible power/water cable 10mm ² 12/18/20-TW / 4m

For 8m long torches:

21	12942811	ST 80 PVC-NIT power/water cable 10mm ² 12/18/20-TW / 8m
21	12942814	HT 105 PVC-NIT power/water cable 10mm ² 12/18/20-TW / 8m
21	12942813	HT 110 rubber fabric hose power/water cable 10mm ² 12/18/20-TW / 8m
21	12942815	HT 130 TPE power/water cable 10mm ² 12/18/20-TW / 8m
21	12942818	HT 180 silicone super flexible power/water cable 10mm ² 12/18/20-TW / 8m

Reel goods:

Prices are per meter and only applicable for purchasing of complete rolls

23	50150001	Meter ST 80 PVC-NIT fabric hose ID5,0-W1,5mm blue for water (100m)
23	51700002	Meter HT 110 rubber fabric hose ID5,0-W1,7mm blue for water (100m)
23.1	50151001	Meter ST 80 PVC-NIT fabric hose ID5,0-W1,5mm red for water (100m)
23.1	51700003	Meter HT 110 rubber fabric hose ID5,0-W1,7mm red for water (100m)
24	31000001	Meter ST 70 PVC hose ID3,0-W1,0mm black for gas (100m)
24	51700001	Meter HT 110 rubber fabric hose ID5,0-W1,7mm black for gas (100m)
24	31200001	Meter HT 130 PUR hose ID3-W1,2mm black for gas (100m)

N.i.	91902701	Meter control line 3x0,34mm ² shielded black (100m)
N.i.	91902711	Meter control line 3x0,5mm ² red (100m)
25	91902721	Meter control line 5x0,25mm ² grey (100m)

12-1-TW

Welding-torch TIG water-cooled

350A at 100% duty cycle (DC) - 260A at 100% duty cycle (AC)

Art.-No.		
26	22150002	Meter neoprene protective hose ID22mm black (40m)
N.i.	91915004	Leather protective hose ID22mm / 1 meter long
N.i.	91915007	Leather protective hose ID22mm / 1 meter long with ball joint and hose connector
N.i.	91915003	Hose connector leather protective hose / protection hose ID19,5mm
34	91901501	Coupling nut IT-G1/4"
N.i.	91901211	Hose connector 4mm fits coupling nut R1/4"
35	91901601	Coupling nut IT-G3/8"
N.i.	91901301	Hose connector 5mm fits Coupling nut R3/8"
36	91901001	Cooling liquid plug nipples EURO
N.i.	91901008	Closing cap blue fits cooling liquid plug nipples EURO
N.i.	91901009	Closing cap red fits cooling liquid plug nipples EURO
37	91904101	Plug 3-poles Tuchel with bayonet-catch
37	91904111	Plug 5-poles Tuchel with bayonet-catch
More control line plugs see appendix D		
40	91900701	Terminal nut insulated fits EURO central adapter
41	91900211	TIG central adapter EURO central adapter water cooled
42	91900301	TIG central adapter identical ESAB, 4 contact pins at position 3,4,5,6
42.1	91918571	TIG power/cooling liquid junction fits ESAB central adapter
42.3	91918312	TIG central adapter SK-35 bayonet connection AD13mm
43	91900901	Coupling nut IT-M10x1 (rounded edges) fits EURO central adapter
45	91918327	Power/water plug fits Fronius with 1 O-ring (OT-M10x1 / like EURO central adapter)
45.1	62190001	O-ring ID6,2-W1,9mm fits Fronius
46	9190417e	Power/water plug fits Dalex (1 O-ring) (OT-12x1)
46-A	9190418n	Power-/gasplug fits Dalex with water deviation to outside, CW-System with 1 O-ring
46.1	63240001	O-ring ID6,3-W2,4mm fits Dalex
47	9190423n	Power/water plug fits Oerlikon with 1 O-ring (OT-M10x1 / like EURO central adapter)
47.1	60717801	O-ring ID6,07-W1,78mm fits Oerlikon
48	9190420n	Power/water plug fits Lorch SK35 + gas-nipple (OT-10x1 / like EURO central adapter)
48.1	91900801	O-ring ID4-W1mm fits gas-nipple EURO central adapter
N.i.	91900552	TIG cable support long (like MIG-MAG) with screws fits ESAB central adapter
N.i.	91900554	Attachment screw M4x8mm fits ESAB central adapter
49	91900557	TIG cable support short with screws (fits water-cooled)
N.i.	91920702	Screw M3x11,5mm for Ratio/Industry/RAUCH handle and cable support
N.i.	91920703	M3 mounting socket for Ratio/Industry/RAUCH handle and cable support
o.A.	91900602	Screw M4x6mm for TIG cable support short
49.1	91901012	Reduction-eyelet (rubber) from ID10,5mm to ID5mm fits TIG cable support short
N.i.	91921701	PUR hose ID8,5-W1,0mm 150mm long fits leading water hoses into cable support
50	91912801	Spring-socket EURO central adapter
51	91912601	Cable support spring fits EURO / ESAB central adapter
52	9190419n	Power/water plug fits Kemppi IT-G1/4" (AG-M10x1 / like EURO central adapter)
53	9190424n	Power/water plug fits Merkle with 2 O-rings (OT-M10x1 / like EURO central adapter)
53.1	81600001	O-ring ID8-W1,6mm fits Lorch/Merkle
54	9190415n	Powerplug fits Cloos (special-plug) (OT-12x1)

12-1-TW

Welding-torch TIG water-cooled

350A at 100% duty cycle (DC) - 260A at 100% duty cycle (AC)

Art.-No.		
60	12391311	Back cap long 12-1-TW
62	12391301	Back cap short 12-1-TW
66	12389001	PTFE-isolator 12-1-TW 200NGR
70	12396161	Collet body 12-1-TW / 1,6
70	12396241	Collet body 12-1-TW / 2,4
70	12396321	Collet body 12-1-TW / 3,2
70	12396401	Collet body 12-1-TW / 4,0
71	12396162	Gas lens large 12-1-TW / 1,6
71	12396242	Gas lens large 12-1-TW / 2,4
71	12396322	Gas lens large 12-1-TW / 3,2
71	12396402	Gas lens large 12-1-TW / 4,0
72	12396164	Jumbo gas lens 12-1-TW / 1,6
72	12396244	Jumbo gas lens 12-1-TW / 2,4
72	12396324	Jumbo gas lens 12-1-TW / 3,2
72	12396404	Jumbo gas lens 12-1-TW / 4,0
73	12396163	Mini-Gas lens 12-1-TW / 1,6
73	12396243	Mini-Gas lens 12-1-TW / 2,4
73	12396323	Mini-Gas lens 12-1-TW / 3,2
73	12396403	Mini-Gas lens 12-1-TW / 4,0
Brazen-collets L-64mm suitable equipment line (A) standard collet body suitable equipment line (B) gas lens Holch suitable equipment line (E) gas lens mini		
75	12166401	Collet L64mm 12-1-TW / 1,6 (triple dagged)
75	12246401	Collet L64mm 12-1-TW / 2,4 (triple dagged)
75	12326401	Collet L64mm 12-1-TW / 3,2 (triple dagged)
75	12406401	Collet L64mm 12-1-TW / 4,0 (triple dagged)
Brazen-collets L-66mm suitable equipment line (A) standard collet body suitable equipment line (B) gas lens Holch suitable equipment line (D) jumbo gas lens suitable equipment line (E) gas lens mini		
76	12166601	Collet L66mm 12-1-TW / 1,6 for Jumbo gas lens
76	12246601	Collet L66mm 12-1-TW / 2,4 for Jumbo gas lens
76	12326601	Collet L66mm 12-1-TW / 3,2 for Jumbo gas lens
76	12406601	Collet L66mm 12-1-TW / 4,0 for Jumbo gas lens
78	12389011	PTFE-Gas-lens insulator for gas lens large 12-1-TW
79	12389021	PTFE-Gas-lens insulator Jumbo 12-1-TW
Ceramic gas nozzles L-44mm suitable equipment line (A) standard collet body suitable equipment line (E) gas lens mini		
80	12393041	Ceramic gas nozzle L44mm 12-1-TW / Gr.4 130.00 (pu= 10pieces)
80	12393051	Ceramic gas nozzle L44mm 12-1-TW / Gr.5 131.00 (pu= 10pieces)

12-1-TW

Welding-torch TIG water-cooled

350A at 100% duty cycle (DC) - 260A at 100% duty cycle (AC)

Art.-No.	
80	12393061 Ceramic gas nozzle L44mm 12-1-TW / Gr.6 132.00 (pu= 10pieces)
80	12393071 Ceramic gas nozzle L44mm 12-1-TW / Gr.7 133.00 (pu= 10pieces)
80	12393081 Ceramic gas nozzle L44mm 12-1-TW / Gr.8 134.00 (pu= 10pieces)
80	12393091 Ceramic gas nozzle L44mm 12-1-TW / Gr.9 135.00 (pu= 10pieces)
80	12393101 Ceramic gas nozzle L44mm 12-1-TW / Gr.10 136.00 (pu= 10pieces)
80	12393121 Ceramic gas nozzle L44mm 12-1-TW / Gr.12 137.00 (pu= 10pieces)

Ceramic gas nozzles different lengths suitable equipment line (B) gas lens Holch

90	22093041 Gas nozzle for gas lens L42mm / Gr.4 54N18 (pu= 10pieces)
90	22093051 Gas nozzle for gas lens L42mm / Gr.5 54N17 (pu= 10pieces)
90	22093061 Gas nozzle for gas lens L42mm / Gr.6 54N16 (pu= 10pieces)
90	22093071 Gas nozzle for gas lens L42mm / Gr.7 54N15 (pu= 10pieces)
90	22093081 Gas nozzle for gas lens L42mm / Gr.8 54N14 (pu= 10pieces)
90	22093111 Gas nozzle for gas lens L42mm / Gr.11 54N19-11 (pu= 10pieces)
90	22093121 Gas nozzle for gas lens L42mm / Gr.12 54N19 (pu= 10pieces)

N.i.	22093054 Gas nozzle for gas lens L76mm / Gr.5 54N17L (pu= 10pieces)
N.i.	22093064 Gas nozzle for gas lens L76mm / Gr.6 54N16L (pu= 10pieces)
N.i.	22093074 Gas nozzle for gas lens L76mm / Gr.7 54N15L (pu= 10pieces)
N.i.	22093084 Gas nozzle for gas lens L76mm / Gr.8 54N14L (pu= 10pieces)

Ceramic gas nozzles jumbo in different lengths suitable equipment line (D) gas lens jumbo

95	22093066 Jumbo gas nozzle L48mm / Gr.6 57N75 (pu= 10pieces)
95	22093086 Jumbo gas nozzle L48mm / Gr.8 57N74 (pu= 10pieces)
95	22093106 Jumbo gas nozzle L48mm / Gr.10 53N88 (pu= 10pieces)
95	22093126 Jumbo gas nozzle L48mm / Gr.12 53N87 (pu= 10pieces)

N.i.	22093067 Jumbo gas nozzle L73mm / Gr.6 57N75L (pu= 10pieces)
N.i.	22093087 Jumbo gas nozzle L73mm / Gr.8 57N74L (pu= 10pieces)
N.i.	22093107 Jumbo gas nozzle L73mm / Gr.10 53N88L (pu= 10pieces)
N.i.	22093127 Jumbo gas nozzle L73mm / Gr.12 53N87L (pu= 10pieces)

Top quality tungsten electrodes in 9 different qualities, see appendix A.